

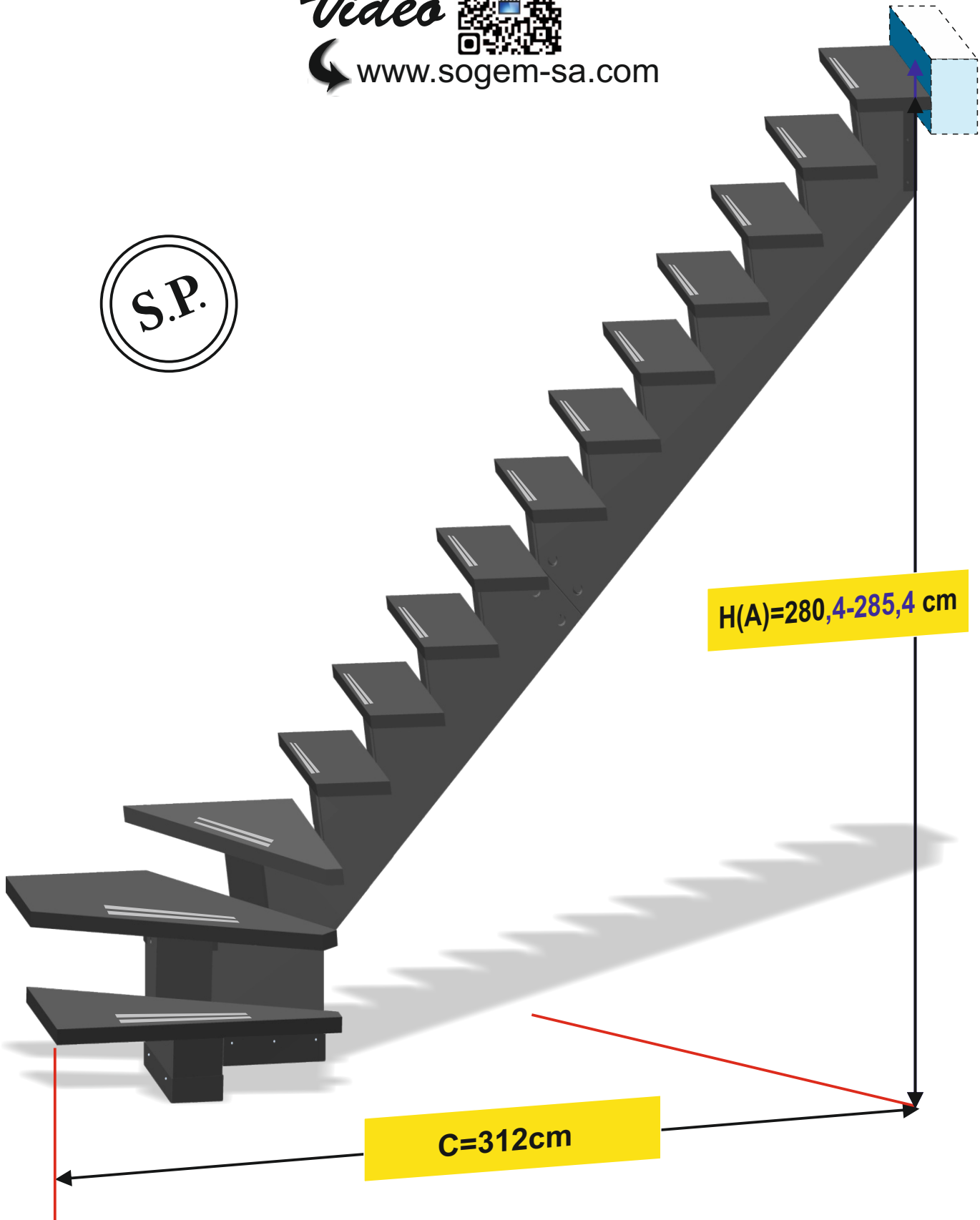

Video
www.sogem-sa.com



GAMME VOLCANO GOMERA ESCALIER QT



01	70043030  1960x390x150mm =1	02	70043032G 70043033D  1920x390x150mm =1	03	70043034G 70043035D  350x380x150mm =1	04	70042040 70042042  275x850x40mm =10
05	70042041 70042043  285x850x040mm =1	06	70042045G 70042046D  538x855x40mm =1	07	70042047G 70042048D  1198x624x40mm =1	08	70042049G 70042050D  850x425x40mm =1
09	70042051D 70042051G  900x80x40 mm =1	10	70042044  700x80x40 mm =12	11	70042052  500x80x40 mm =1	12	70041030  Φ5x25 mm =84+2
13	70031033  M8x160mm =4	14	70031034 70031030  a Φ40xΦ37x19mm =8 b 35x11x18mm =8	15	70041058  M6x50mm =24+1	16	70031031  M8 =8
17	70041005  Φ10x40mm =4	18	70041006  Φ12x60mm =8	19	70031035 70031036  a M10x55mm =4 b Φ20x20xmm =4	20	70041059  Φ16x15mm =24
21	70031037  M8 =4	22	70041007  Φ7x40mm =21+1	23	70041027  Φ6,3x60mm =32+2	24	70041031 70041037 70041038  a Φ16xΦ20mm =52+2 b Φ20xΦ24mm =2 c Φ20x4mm =2
25	70041032  Φ43xΦ50mm =8	26	70041035G 70041036D  456x164x090mm =1	27	70041039  374x165x90mm =1	28	70041034  315x162x50mm =1
29	70041025  350x150x10mm =5	30	70041028  hex 4mm =1	31	70041060  20 ml =1	32	70041026  450x150x10mm =5



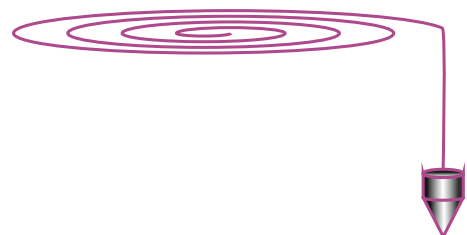
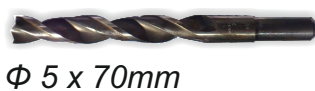
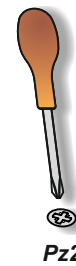
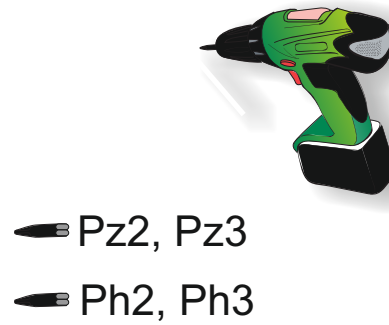
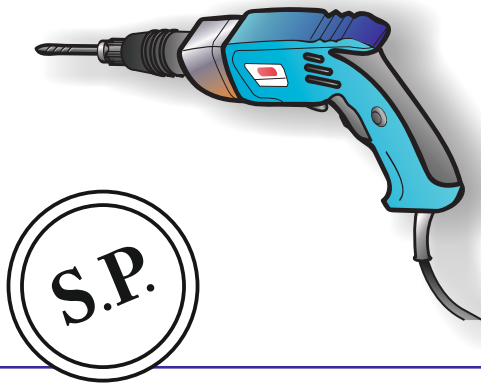
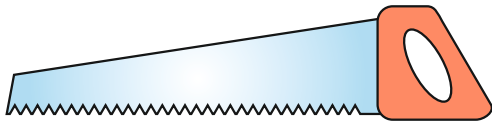
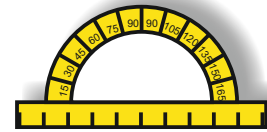

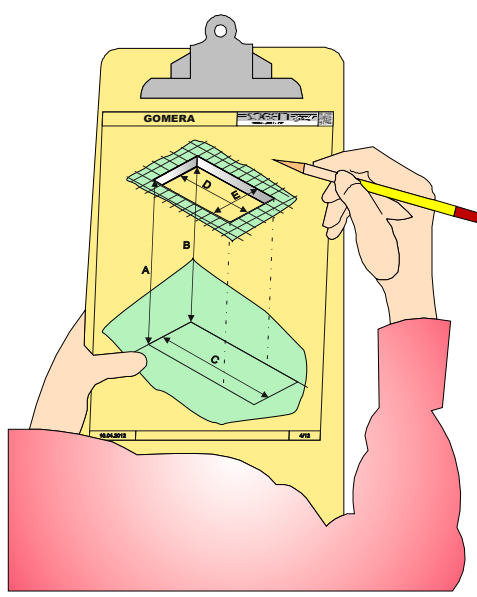
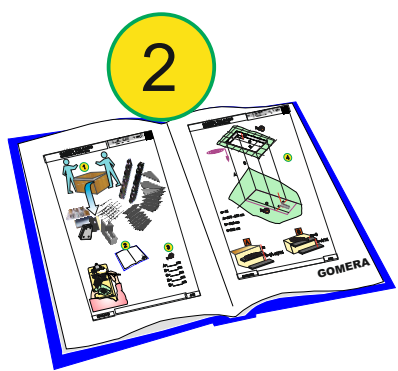
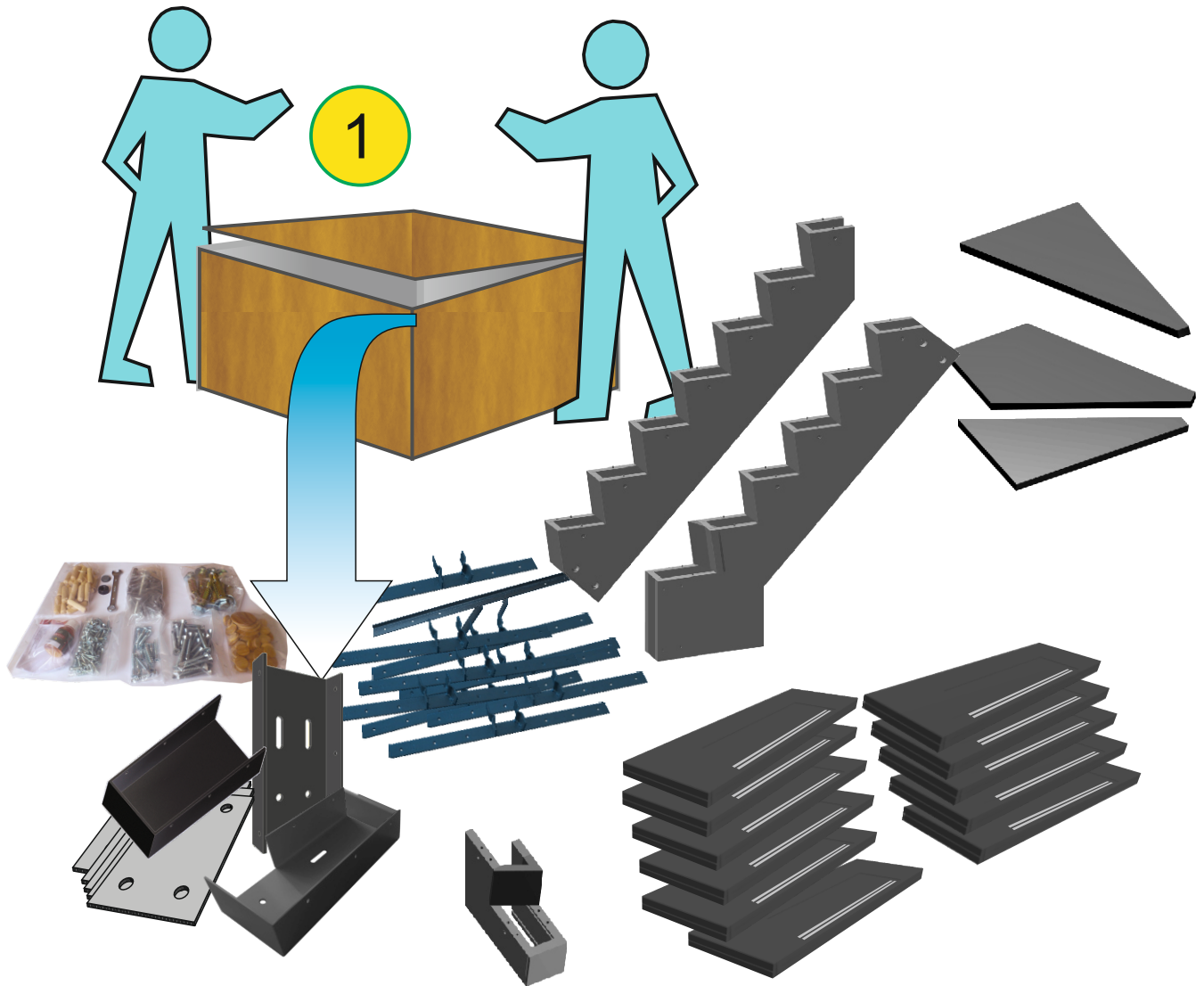

- A= _____ cm
- B= _____ cm
- C= _____ cm
- D= _____ cm
- E= _____ cm



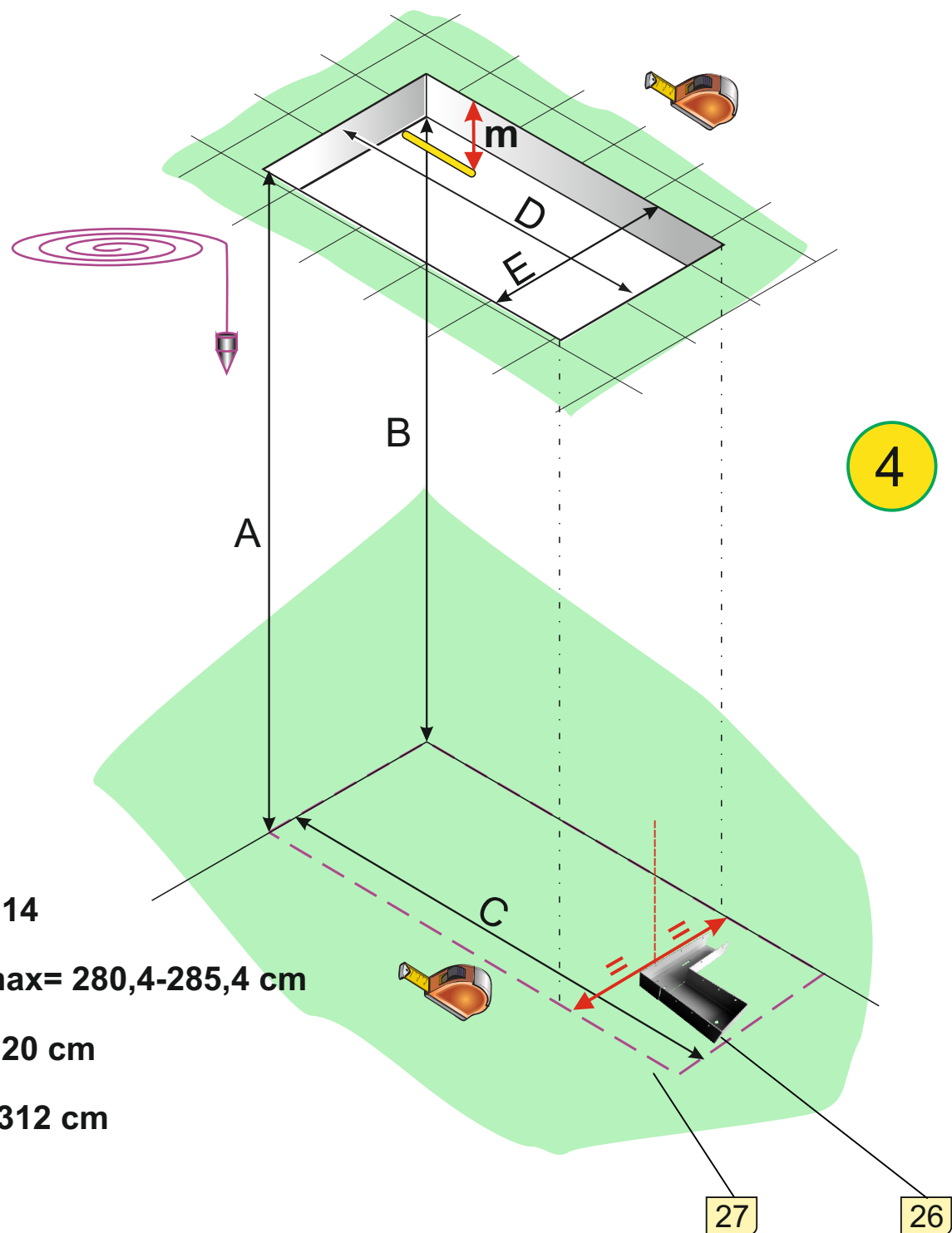

n= 14
Amax= 280,4-285,4 cm
h= 20 cm
C=312 cm

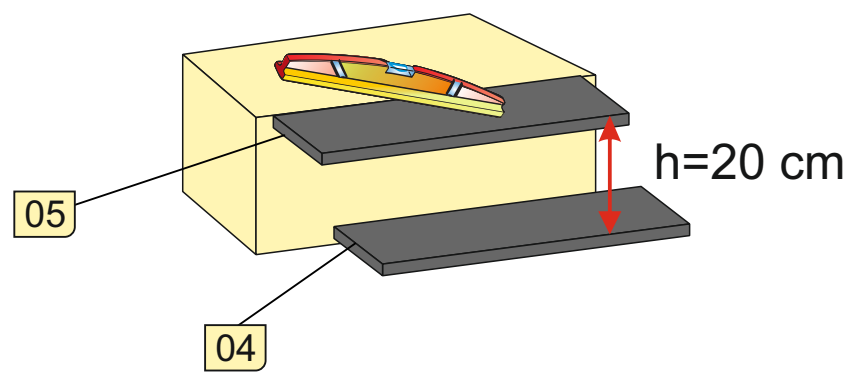

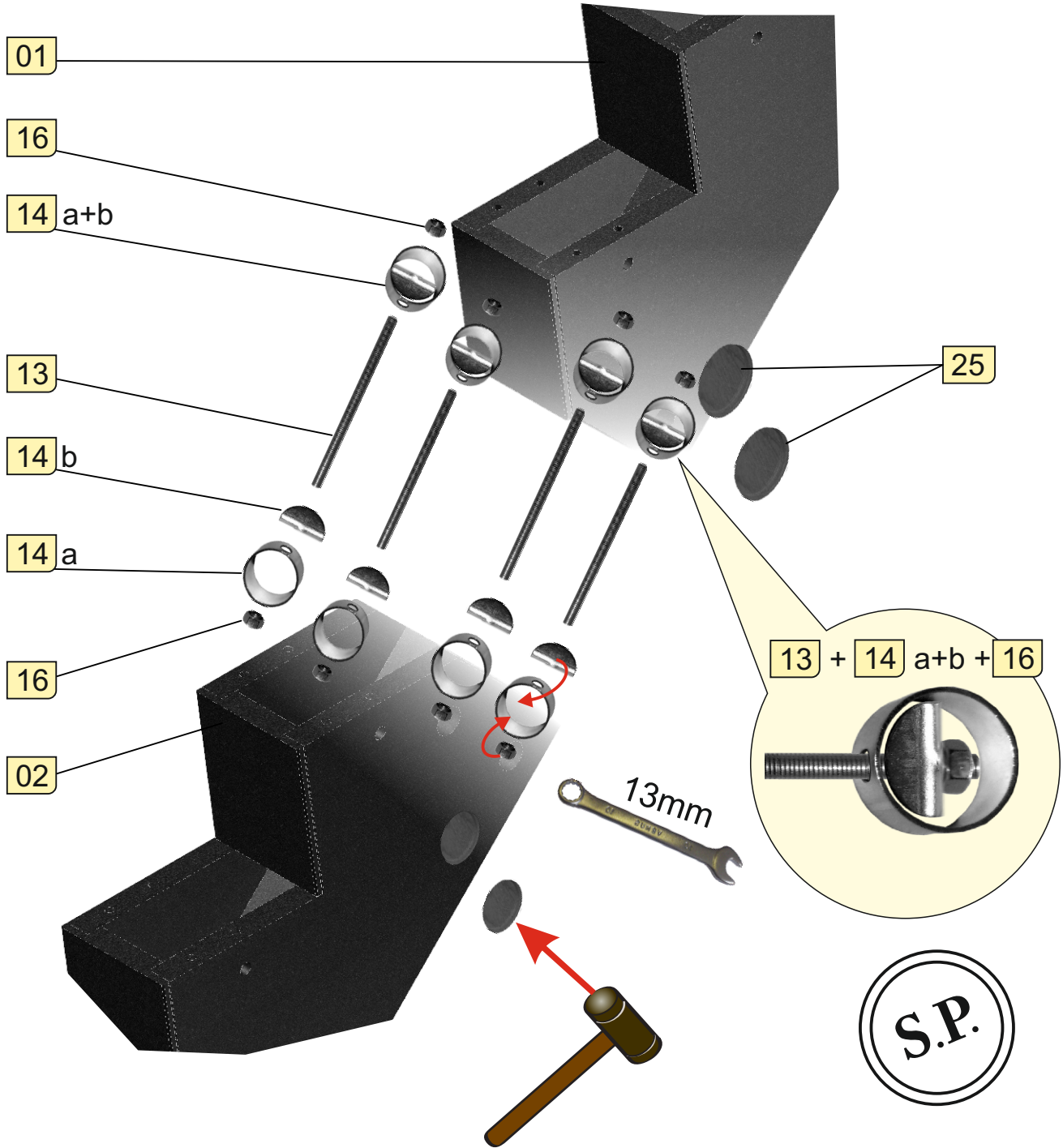
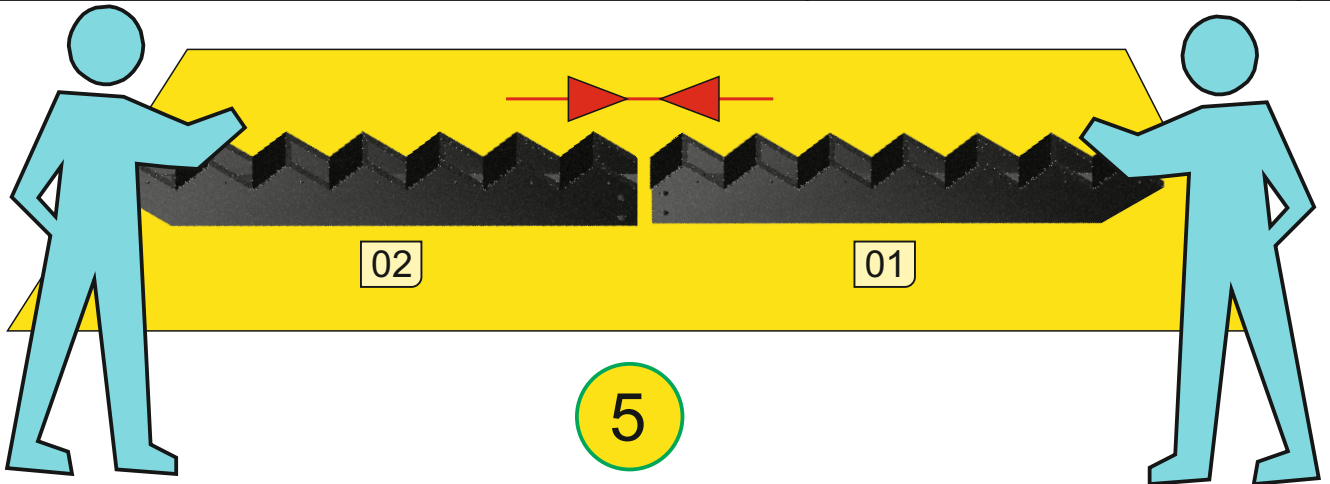

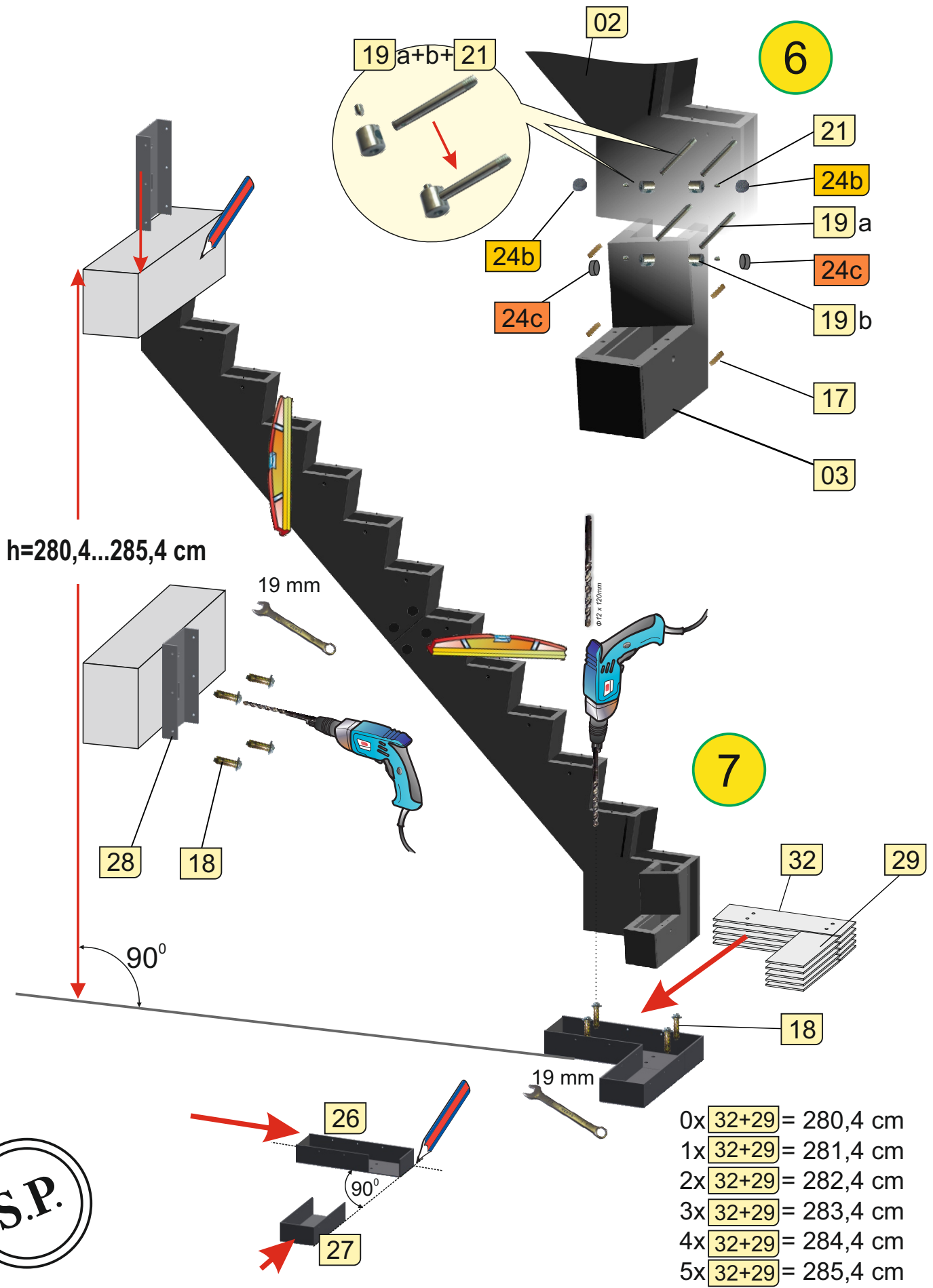

6

7

S.P.

- 0x $32+29 = 280,4$ cm
- 1x $32+29 = 281,4$ cm
- 2x $32+29 = 282,4$ cm
- 3x $32+29 = 283,4$ cm
- 4x $32+29 = 284,4$ cm
- 5x $32+29 = 285,4$ cm



8

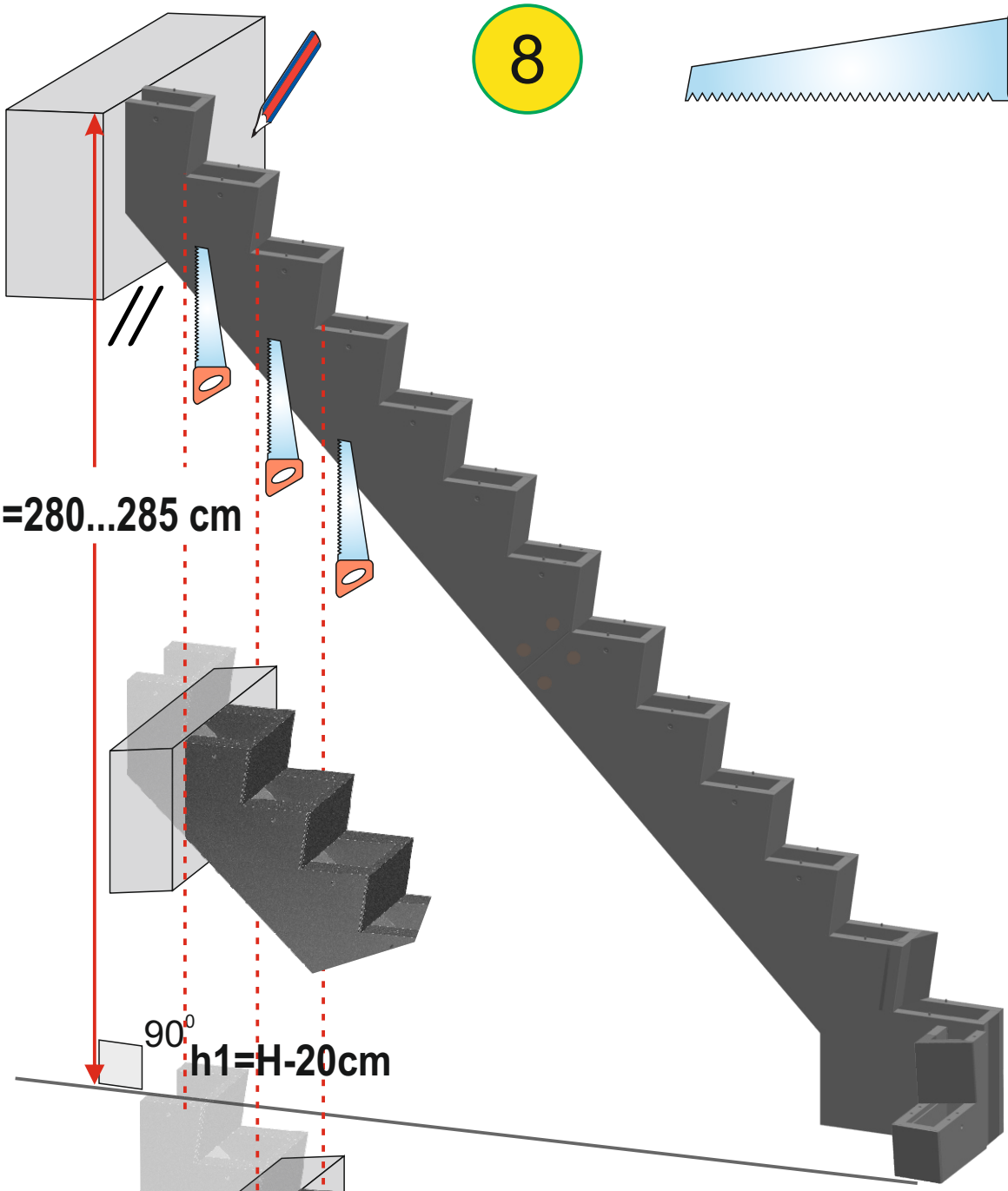
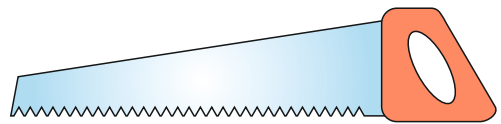

H=280...285 cm

**90°
h1=H-20cm**

h2=H-2x20cm

h3=H-3x20cm





9

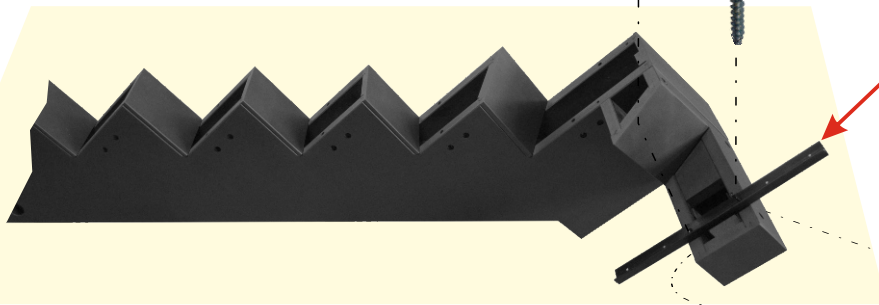
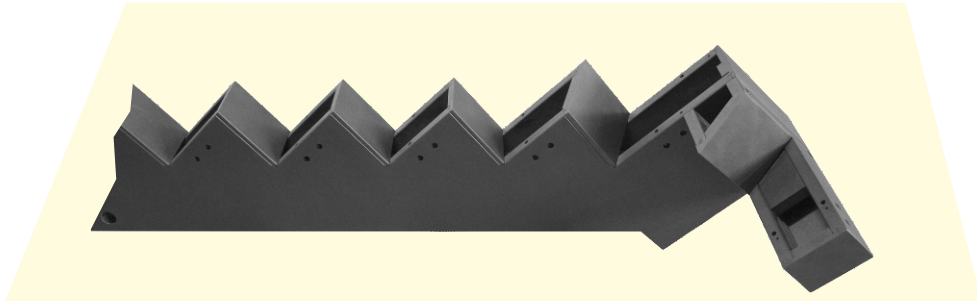

A

22 x 2

11 x 1

B

23 x 2



06 x 1

03 x 4

24a x 4

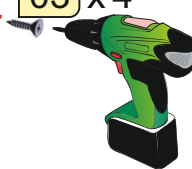

S.P.

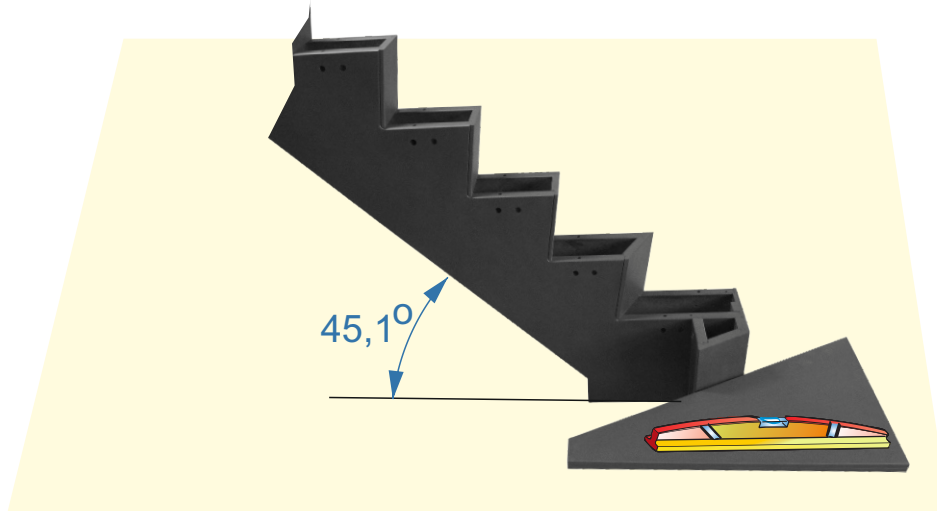

45,1°

10

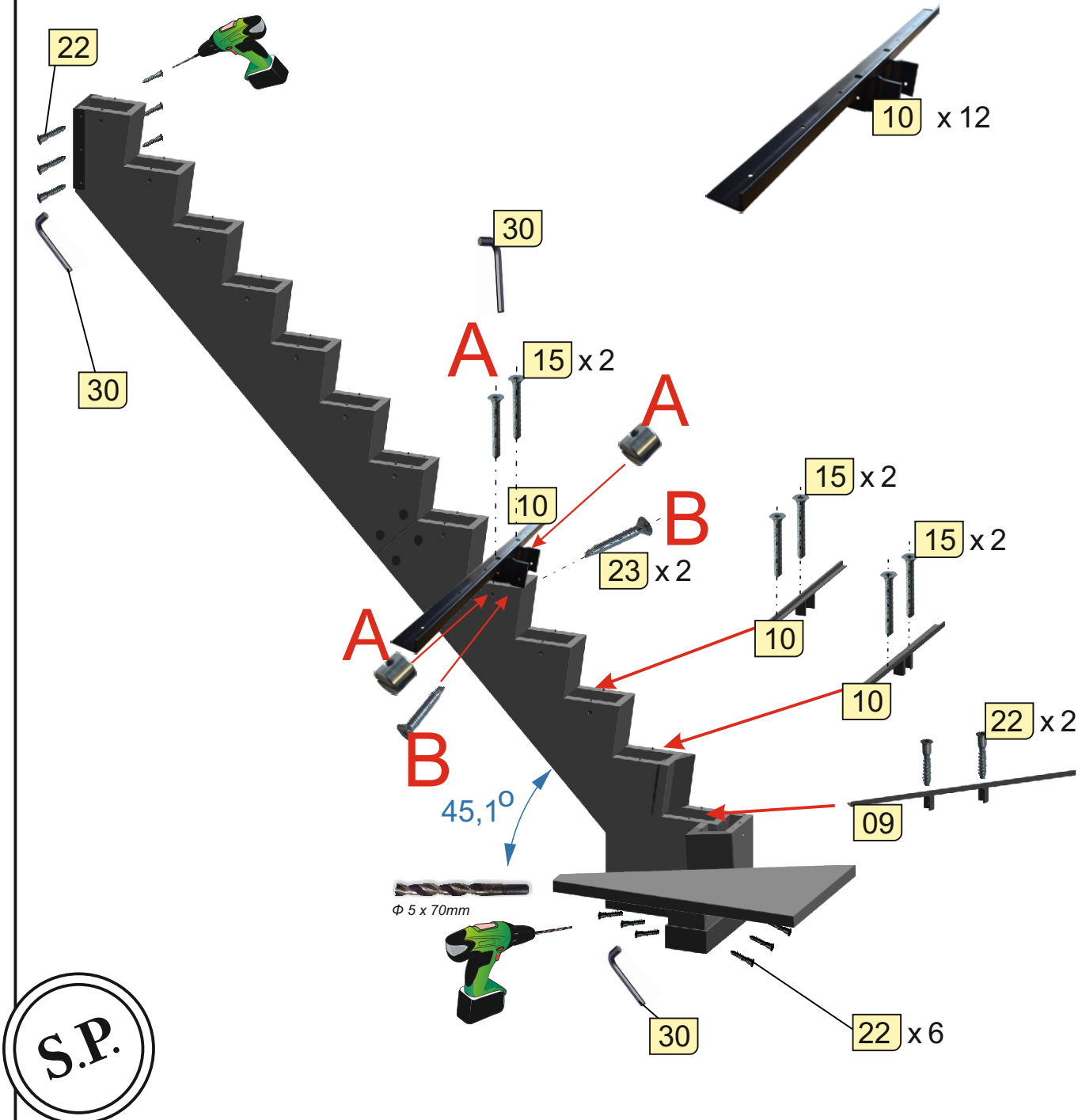



kit LED

11

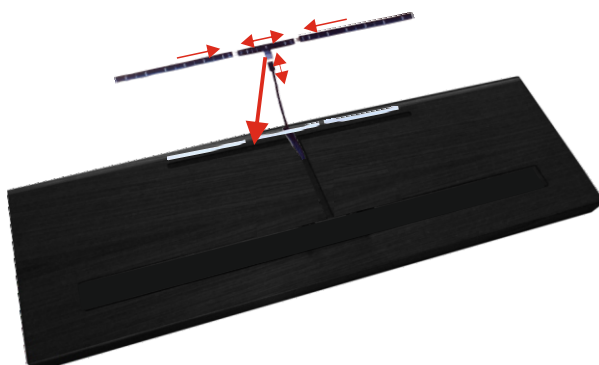
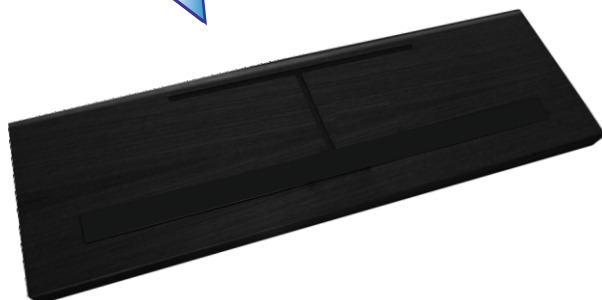



12

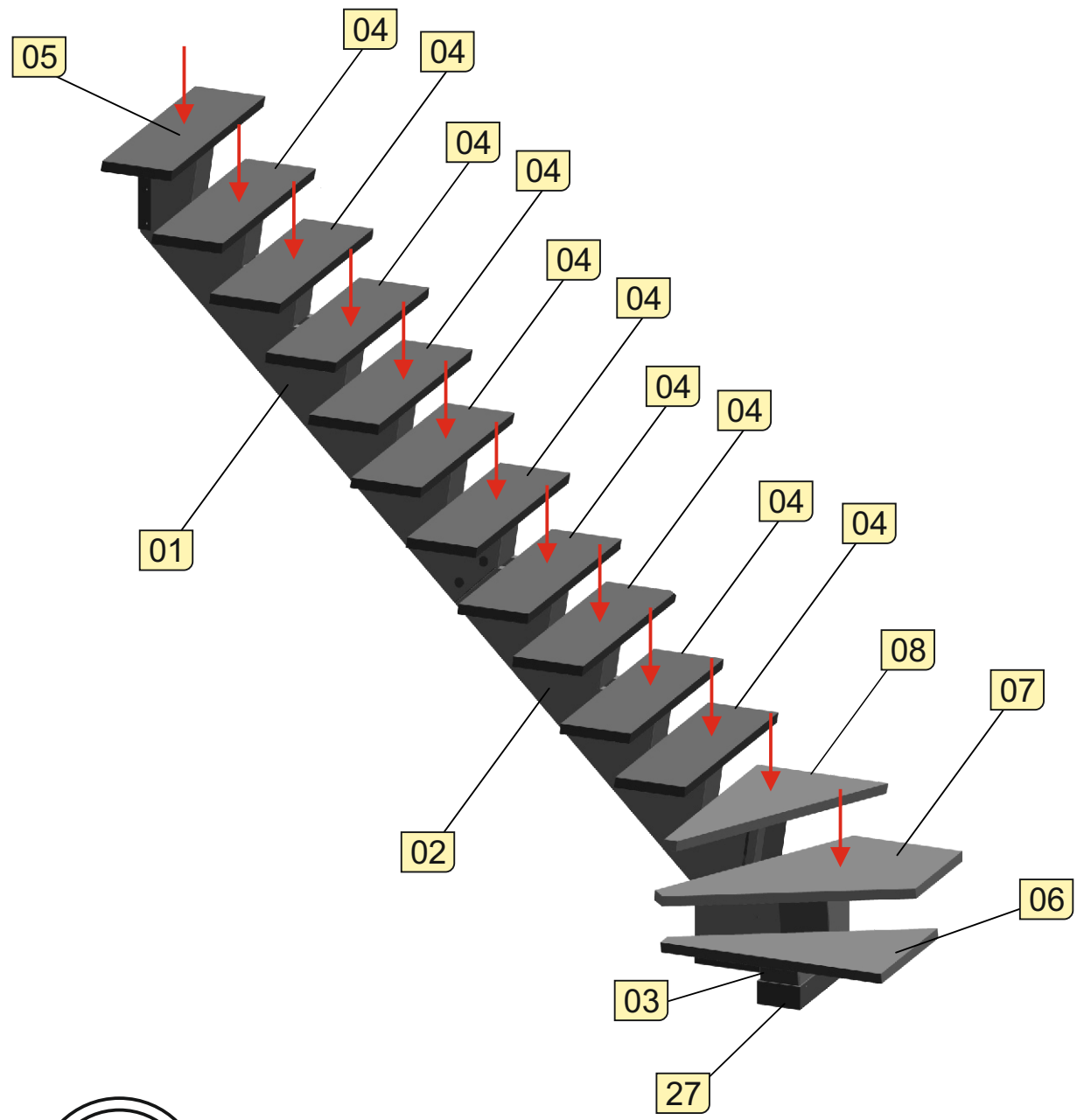



13

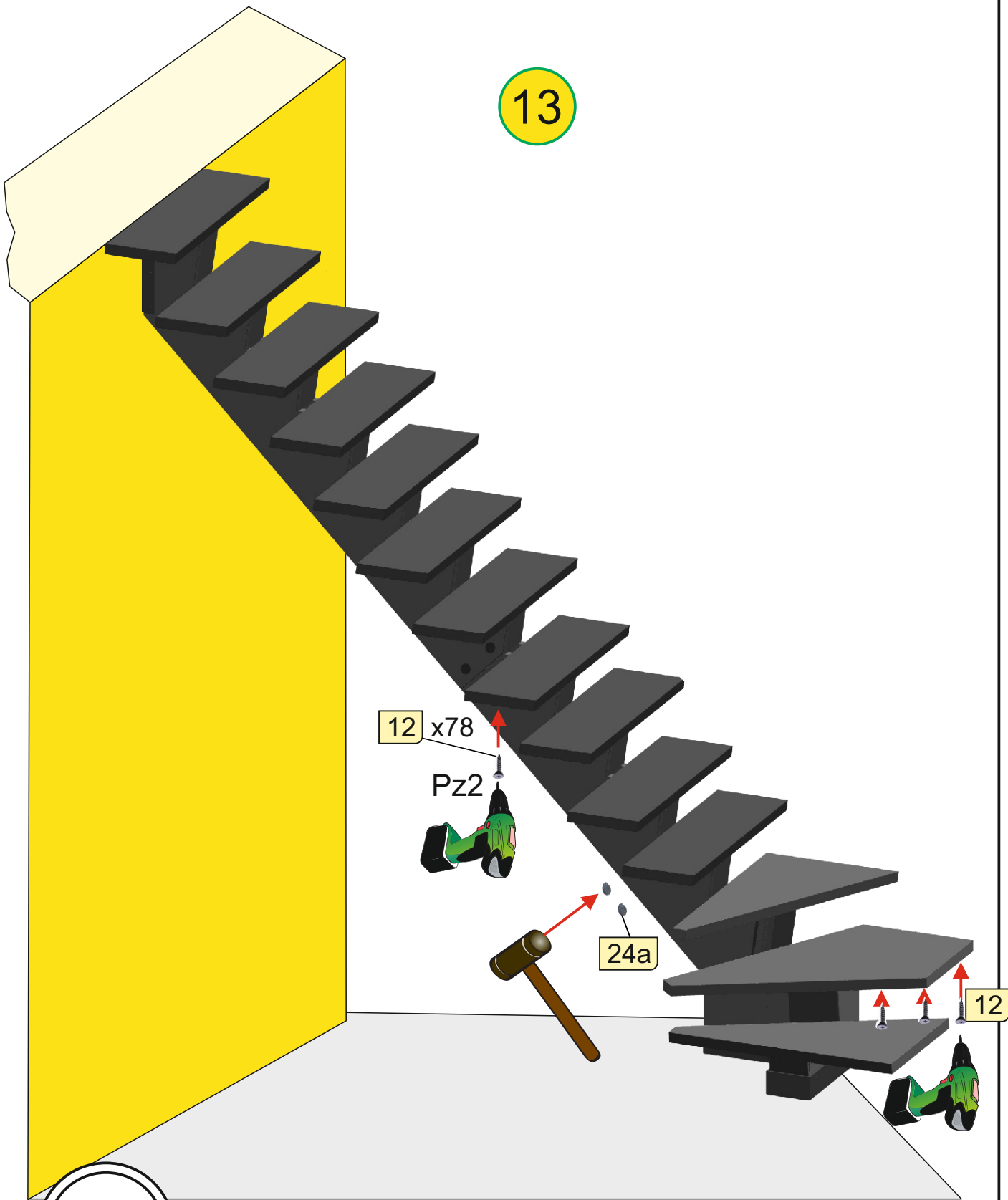

S.P.